

FINISH SPECIFICATION

GRATE FRAME: BLACK POLYESTER POWDER COAT
HOT DIP GALVANIZE - OPTIONAL
STAINLESS STEEL - OPTIONAL
CAST GRATE : UNCOATED - STANDARD
HOT DIP GALVANIZE - OPTIONAL

38% OPEN AREA
118.7 SQUARE INCHES
PER LINEAR FOOT

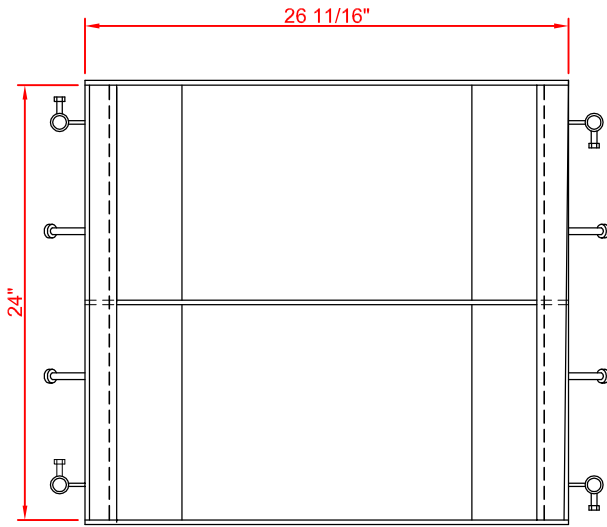

PLAN VIEW

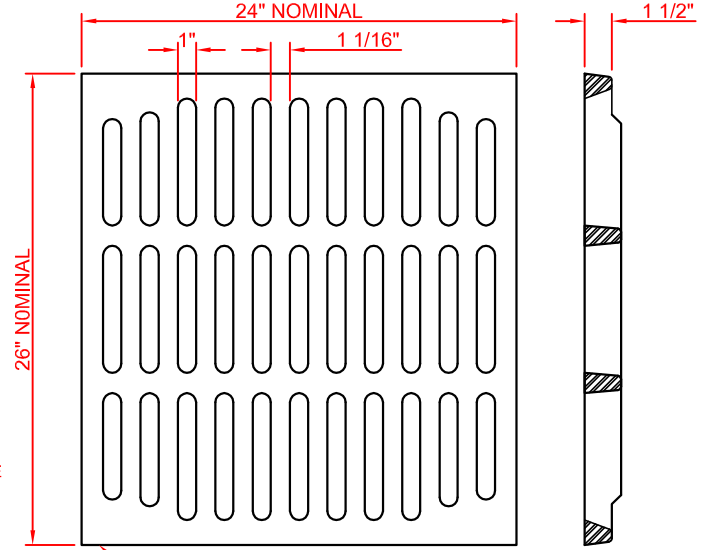

H20 CAST IRON GRATE #MG-2624-CI-A
(INSTALLED AFTER REMOVAL OF EPS FORM)
NOTE
PLEASE CONTACT MULTIDRAIN SYSTEMS, INC.
FOR ADDITIONAL GRATE OPTIONS. GRATE SHOULD
MATCH THOSE USED ON ADJOINING TRENCH SYSTEM.

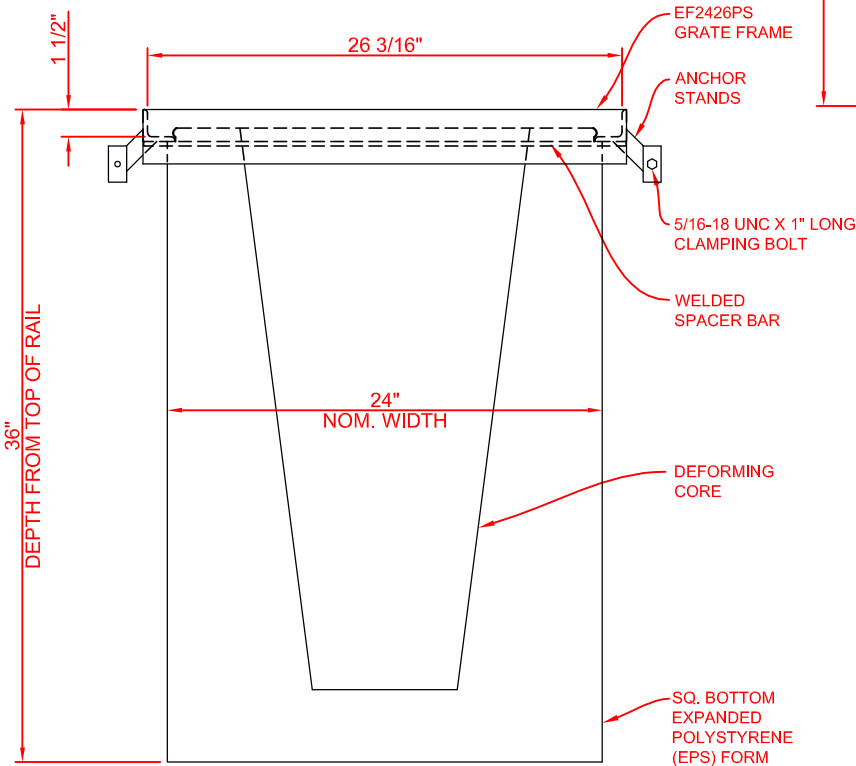

END VIEW

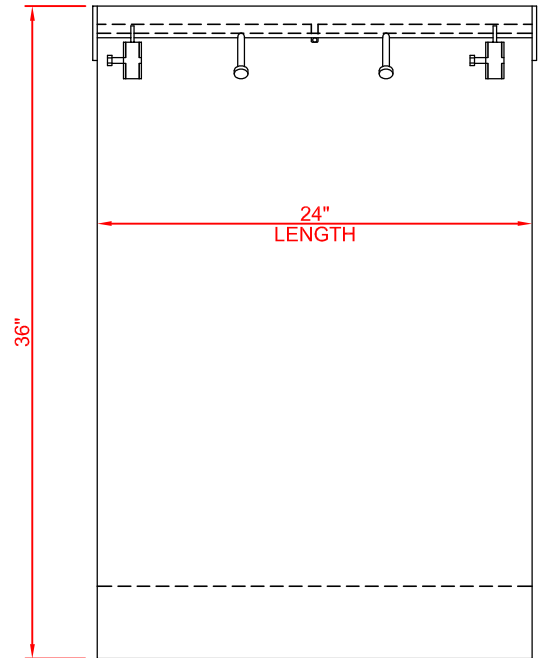

SIDE VIEW

NOTES:

1. INSTALLATION TO BE COMPLETED IN ACCORDANCE WITH MANUFACTURER'S SPECIFICATIONS AND INSTALLATION INSTRUCTIONS.
2. A TRENCH SHALL BE EXCAVATED A MINIMUM OF 12" WIDER THAN THE OVERALL WIDTH OF THE STEEL FRAME (6" MINIMUM EACH SIDE) AND A MINIMUM OF 6 INCHES DEEPER THAN THE OVERALL DEPTH OF THE ECONODRAIN EPS FORM.
3. DO NOT SCALE DRAWINGS.

Copyright © 2014 MultiDrain Systems, Inc.



1405 INDUSTRIAL DRIVE
STATESVILLE, NC 28625
(704) 508-1010
1-800-433-1119
www.multidrain.com

EconoDrain® Catch Basin
w/ MG-2624-CI-A Cast Iron H-20 Grate (Standard)

FILE NUMBER:

CSI-ED-ECB-2436-15a

REV: 00

Proprietary rights of MultiDrain Systems, Inc. are included in the information disclosed herein. The recipient, by accepting this document, agrees that neither this document nor the information disclosed herein nor any part thereof shall be copied, reproduced or transferred for manufacturing or for any other purpose except as specifically authorized in writing by MULTIDRAIN.

DISCLAIMER: The customer and the customer's architects, engineers, consultants and other professionals are completely responsible for the selection, installation, and maintenance of any product purchased from MultiDrain, and EXCEPT AS EXPRESSLY PROVIDED IN MULTIDRAIN'S STANDARD WARRANTIES, MULTIDRAIN MAKES NO WARRANTY, EXPRESS OR IMPLIED, AS TO THE SUITABILITY, DESIGN, MERCHANTABILITY, OR FITNESS OF THE PRODUCT FOR CUSTOMER'S APPLICATION. Copies of MultiDrain's standard warranties are available upon request.